

System description EY-modulo 2

7010038003 A

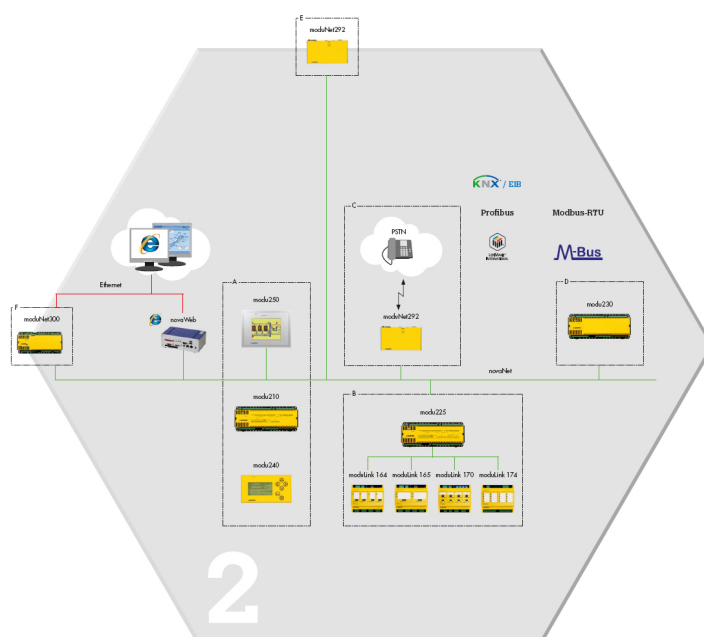

Table of contents

1	Introduction	5
2	System overview	7
3	EY-modulo 2 automation stations	11
3.1	modu 2 automation stations	12
3.2	moduFlex universal controller	12
3.3	moduLink field modules	13
4	SAUTER ecos room automation	15
4.1	ecos 2 intelligent unitary controllers and room automation stations	15
4.2	ecoUnit room operating units	17
5	Local operation	19
5.1	Local operating unit, modu240	19
5.2	modu250 touch-panel	20
6	novaNet communication network	21
6.1	novaNet specifications	22
6.2	moduNet180 repeater	23
6.3	moduNet292 Ethernet interface	23
6.4	novaNet291 router	24
6.4.1	Remote access function	24
6.4.2	Remote monitoring	25
7	Management level:	27
7.1	novaPro software management level	27
7.2	novaWeb embedded web server	28
8	Backwards and upwards compatibility, non-Sauter connections	31
8.1	Direct backwards compatibility with SAUTER EY3600	32
8.2	BACnet and SAUTER EY-modulo 5 via moduNet300	32
8.3	Non-Sauter systems at AS level via modu230	33
8.4	OPC-compatible management systems via novaNet OPC server	35
8.5	Non-Sauter and SAUTER systems via novaPro	36
8.5.1	SAUTER EY3600	37
8.5.2	SAUTER EY2400	37
8.5.3	LON, SAUTER EY-modulo 4	37
8.5.4	BACnet, SAUTER EY-modulo 5	37
8.5.5	Non-Sauter systems via drivers	38
8.5.6	Non-Sauter systems via databases	38
9	Additional documentation	39
	Figures	41
	Tables	43

1 Introduction

EY-modulo 2 is a very favourably-priced building automation system, in terms of both engineering and installation. It is based on the proprietary **SAUTER novaNet** communication platform that is optimised for building automation and is extremely robust.

EY-modulo 2 offers all the functions and properties required of a modern building automation system. It is open for integration into/of one or more non-Sauter systems and is totally backwards- and upwards-compatible. The tried-and-tested technology, together with the distributed intelligence, ensures very reliable operation.

Together with the **CASE Suite** engineering software and the **SAUTER libraries** that contain **SAUTER's accumulated project know-how**, it can be used to implement projects with the greatest efficiency.

The complete system comprising **EY-modulo 2**, the **novaPro** management level, the **CASE Suite** engineering software and **SAUTER libraries** offers a very comprehensive package to increase energy efficiency, in the planning as well as the running of buildings!

2 System overview

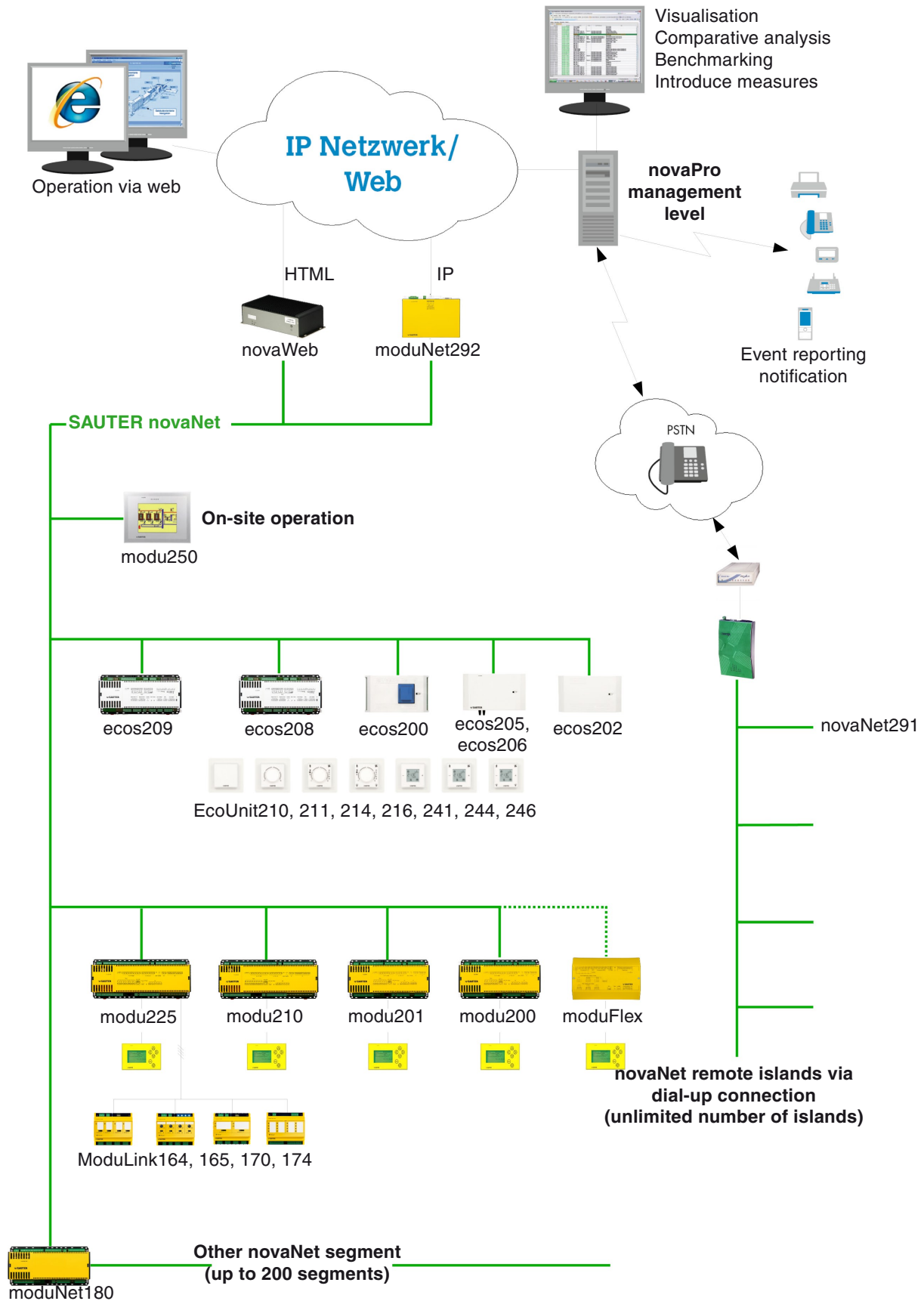

Fig. 1 System overview

System overview

The **modu 2** and **ecos 2** automation and room automation stations form the basis of this complete system family that is used to regulate, control and monitor building services installations.

The complete **EY-modulo 2** system comprises these components:

- The **SAUTER modu 2** and **SAUTER moduFlex** automation stations
- The **SAUTER ecos 2** room automation stations
- The **SAUTER modu240** and **SAUTER modu250** local operating units
- The **SAUTER ecoUnit 2** room operating units
- Web operation with **SAUTER novaWeb** (or via management level)
- The **SAUTER novaPro** management level
- Various **SAUTER moduNet** and **Sauter novaNet** communication components
- The **SAUTER CASE Suite** engineering software
- The **SAUTER solution libraries**

and the devices for heterogeneous plants:

- The **SAUTER modu230** station with interface for non-Sauter connections
- The **SAUTER moduNet300** BACnet Application Master
(see section: ‚Non-Sauter connections, upwards and downwards compatibility‘)

All components at automation level communicate via the plant-wide **novaNet** system bus, which is optimised for building automation. The direct and unrestricted flow of information ensures reliable operation and largely eliminates the need for interfaces.

The **EY-modulo 2**, **moduFlex** and **ecos 2** stations, which have equal rights and are freely programmable, exchange data via cross-traffic (peer-to-peer) and consistently put the concept of ‚distributed and local intelligence‘ into practice.

Remote field modules in the **moduLink** series extend the I/O mix of the **modu225** automation station and extend it by adding status display, manual operation and emergency/standby operating functions. In their function as logical terminals, they can be positioned wherever the inputs/outputs are required, thereby optimising the electrical installation.

The **modu250** and **modu240** local operating units allow comprehensive visualisation of information, as well as navigation and local operation of the automation station and its plants. The practical mobile **modu240** display and operating units, which require no programming, can be connected to every automation station. The **modu250** graphic operating unit allows plant-wide operation via a touch-sensitive graphic interface.

The **ecoUnit210**, **-211**, **-214**, **-216**, **-241**, **-244** and **-246** room operating units connected to the **ecos 2** room automation stations are used to measure the temperature of the room, for individual presence and absence settings, for room setpoint correction and to control lighting and window blinds.

The PCs for the **novaPro** management level software can be connected directly to the system bus or connected to one another via a LAN/WAN network. The operation of the building management system can therefore be fully integrated into a company's intranet/internet network infrastructure. Events and protocols can be forwarded, dependent on time and priority, to a wide range of destinations such as printers, e-mail, fax, pagers and personal paging systems etc.

Visualisation and operation can also be handled via the intranet or internet using any standard web browser, either via the **novaWeb** Web server, directly at automation level, or via the management level with **novaPro**.

Additional segments can be added to the **novaNet** system bus for extensive systems with the help of the novaNet repeater, **moduNet180**.

By using **novaNet291** routers and modems, distant novaNet segments can be connected to the plant via the public telecommunications network. On the one hand, this allows access from the management level to remote plants (remote access) and on the other, distant buildings (AS networks) can signal important alarms and events (configurable) to the management level (remote monitoring).

Various possibilities are available for the integration of non-Sauter systems, at both automation and management levels (see the section: 'Forwards and backwards compatibility, non-Sauter connections').

System overview

3 EY-modulo 2 automation stations

The automation stations are normally used in the energy processing for the building.

The range comprises four compact stations, one universal controller and the associated field modules.

Type



EY-AS200F001

EY-AS201F001

EY-AS210F001

EY-AS225F001

EYR203F001

Name Device	modu200 Compact automation station	modu201 Compact automation station	modu210 Compact automation station	modu225 Compact automation station	moduFlex Universal controller
Bus novaLink	novaNet –	novaNet –	novaNet –	novaNet ✓	novaNet
Inputs analogue	26 7 (Ni/Pt1000) 5 (U/Pot/(I))	28 2(U/Pot/(I))	28 8 (Ni/Pt1000) 6 (U/I/R)	28...76 8 (Ni/Pt1000) 6 (U/I/R)	18 8 (2 of which can be used as pulse counters)
non-isolated digital	✓ 12	✓ 24	✓ 12	✓ 12 can be extended by 48 with moduLink	– 5 (Ni/Pt1000) 5 (0...10 V)
Pulse counter	2	2	2	2	–
Outputs analogue	12 4 (0...10 V)	10 2 (0...10 V)	14 6 (0...10 V) 2 x 0...20 mA	14...26 6 (0...10 V) 2 x 0...20 mA	10 4 (0...10 V)
digital	6 (0-I)	8 (0-I)	8 (0-I)	8 can be extended by 8 (0-I-II) with moduLink	2 (O-I) 2 (O-I-II)
Over-voltage protection	–	–	–	–	–
Hardware addresses	36	38	42	102	–
Software addresses	220	218	214	154	–
Maximum number	256	256	256	256	–
Scanning time for control loops	1000 ms	1000 ms	1000 ms	1000 ms	–
Interfaces	novaNet modu240	novaNet modu240	novaNet modu240	novaNet modu240	novaNet modu240
	1 a/b terminal 1 RJ-45	1 a/b terminal 1 RJ-45	1 a/b terminal 1 RJ-45	1 a/b terminal 1 RJ-45	a/b terminal RJ-45 socket
Program storage System programs PROM	✓	✓	✓	✓	–
Program storage User programs PROM	✓	✓	✓	✓	–
Program storage Process data, variables SRAM	✓	✓	✓	✓	–
Data buffer for power failure	3 years	3 years	3 years	3 years	–
Power supply	24 V~/=	24 V~/=	24 V~/=	24 V~/=	24 V~

Tab. 1 EY-modulo 2 automation stations

EY-modulo 2 automation stations

3.1 modu 2 automation stations

The four types of automation station – **modu200**, **modu201**, **modu210** and **modu225** – are graduated with an I/O mix that is appropriate for the building technology (i.e. numbers and types of inputs and outputs).

The same microprocessor and a largely identical microprogram (firmware) are used in all the stations. This microprogram is stored in a PROM memory. It reads all the inputs, processes the parameterised modules, updates the outputs and effects the necessary communication with other stations and the visualisation PCs.

All the automation stations can be freely programmed with a user program. Programming is graphics-based and largely automated thanks to **CASE Suite**. SAUTER's know-how regarding HVAC systems, constantly expanded over the decades, is stored in standard modules – the firmware modules, function groups and solutions (entire heating, ventilation and air-conditioning plants) – in the **SAUTER libraries**. The programming for each specific assignment is therefore reduced to selecting and connecting the appropriate modules. This allows users to make program changes independently, even if they lack in-depth knowledge.

The user programs can be loaded into the stations from any point in the building automation network. The programs are stored in storage modules that are protected against mains failures, and they can be backed up permanently with a User-PROM. This ensures a high degree of protection against data losses.

This tried-and-tested technology guarantees exceptionally high operating reliability for these automation stations.

3.2 moduFlex universal controller





The **moduFlex** universal controller is based on exactly the same technology as the **modu 2** automation stations, and has the same general features.

However, it is designed as a stand-alone controller to regulate and control small and medium-sized standard applications in HVAC technology. The controller is supplied with a selection of ready-to-operate application programs (novaClim, novaTherm) and requires no engineering.

If necessary, however, the controller – like the **modu 2** stations – can be freely programmed. The additional **novaNet** module gives the controller the ability to communicate and enables it to be networked (so it also becomes programmable). The additional ‚point-to-point‘ module can be used with a **modu250** touch-panel.

3.3 moduLink field modules

The **modu225** automation station makes it possible to control remote field modules. These expand the I/O mix of the **modu225**. They also have status display, manual operation and emergency operation functions, and they allow the electrical connections to be positioned where they are needed.

Type				
	EY-FM164F001	EY-FM165F001	EY-FM170F001	EY-FM174F001
Name Device	moduLink164 Field module, digital outputs 0-I	moduLink165 Field module, digital outputs 0-I-II	moduLink170 Field module, analogue outputs	moduLink174 Field module, digital inputs
For stations Bus	EY-AS225F001 novaLink	EY-AS225F001 novaLink	EY-AS225F001 novaLink	EY-AS225F001 novaLink
Inputs digital	–	–	–	16 (potential-free)
Outputs analogue	4	2	4 (0...10 V) or 2 (0...10 V) and 2 (0...20 mA)	–
digital	4 (0-I)	2 (0-I-II)	–	–
Power consumption Power supply	150 mA from EY-AS225F001	150 mA from EY-AS225F001	100 mA from EY-AS225F001	120 mA from EY-AS225F001

Tab. 2 moduLink field modules

The field modules can be used in the MCC – e.g. if the MCC is separated into a power and a DDC panel – or in the MCC door in order to use the display and manual operation functions. Alternatively, they are used directly in the operating plant, where they optimise the wiring because they function as logical terminals. They are mounted on a top-hat rail, EN 50022. The switching modules also contain the connecting relays for 250 V~ / 2 A.

The **novaLink** connection between the automation stations and the field modules is made using a twisted, screened two-core cable, which is earthed on both sides, in the form of a point-to-point connection to each unit. If standard cables are used, the distance between the **modu225** and the field modules may be up to 100 m.

The modules with digital inputs/outputs (DI, DO), **moduLink164**, **-165**, and **-174**, have LED displays for current input/output signals. The modules with outputs (DO, AO), **moduLink164**, **-165**, and **-170**, have an emergency operating function in which the outputs are set to statuses/values that were preselected with DIP switches or trimmer potentiometers. In order to maintain these emergency operating functions even if there is a loss of power supply from the AS, they also have connections for an emergency power supply.

EY-modulo 2 automation stations

4 SAUTER ecos room automation

The **ecos 2** intelligent unitary controllers and room automation stations constitute a range of modulo 2 stations specifically designed for the requirements of individual room control (IRC).

4.1 ecos 2 intelligent unitary controllers and room automation stations

All the stations in the **SAUTER ecos** system family use the same system bus and the same 32-bit microprocessor as the automation stations, so they are fully integrated into the complete system.

The seven types are graduated according to applications and I/O mix, with three intelligent unitary controllers, two volume flow controllers ...

Type					
	EYE200F001	EYE200F002	EYE202F001	EYE205F002	EYE206F002
Name Device	ecos200 DDC controller	ecos200 DDC controller	ecos202 DDC controller	ecos205 DDC VAV controller	ecos206 DDC VAV controller
Data transmission	novaNet	novaNet	novaNet	novaNet	novaNet
Inputs	4 1 (EYB2../EY-RU2..) 1 (Ni1000), 2 (control contacts)	4 1 (EYB2../EY-RU2..) 1 (Ni1000), 2 (control contacts)	7 1 (EYB2../EY-RU2..) 2 (Ni1000), 1 (0...10 V), 3 (control contacts)	6 1 (EYB2../EY-RU2..) 1 (Ni1000), 1 (0...10 V), 2 (control contacts) 1 (static pressure difference)	8 1 (EYB2../EY-RU2..) 2 (Ni1000), 1 (0...10 V), 3 (control contacts) 1 (static pressure difference)
Outputs analogue	7	8	7	3	6
digital	2	2	2	1	2
Functions	2 (0-I-II) triacs, 3 (0-I) relays	2 (0-I-II) triacs, 4 (0-I) relays	2 (0-I-II) triacs, 3 (0-I) relays	2 (0-I-II) triacs	3 (0-I-II) triacs, 1 (0-I) relays
Power supply	Time and calendar function, historical data	Time and calendar function, historical data	Time and calendar function, historical data	Time and calendar function, historical data	Time and calendar function, historical data
Dimensions (mm)	230 V~	230 V~	24 V~	24 V~	24 V~
	178 x 103 x 53	178 x 103 x 53	178 x 103 x 42	178 x 103 x 42	178 x 103 x 42

Tab. 3 ecos 2 intelligent unitary controller

SAUTER ecos room automation

... and two room automation stations:

Type

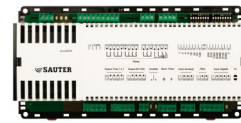
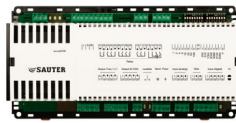

EY-RC208F001

EY-RC209F001

Name	ecos208	ecos209
Device	Room automation station	Room automation station
Data transmission	novaNet	novaNet
Inputs	8 1 (EYB2../EY-RU2..) 2 (Ni/Pt1000), 1 (0...10 V=), 4 (control contacts)	8 1 (EYB2../EY-RU2..) 2 (Ni/Pt1000), 1 (0...10 V=), 4 (control contacts)
Outputs	14	18
analogue	4	4
digital	2 (0-I-II) triacs, 5 (0-I) relays 1 change-over relay	2 (0-I-II) triacs, 9 (0-I) relays 1 change-over relay
Functions	Time and calendar function, historical data	Time and calendar function, historical data
Power supply	230 V~	230 V~
Dimensions (mm)	244 x 120 x 73	244 x 120 x 73

Tab. 4 ecos 2 room automation stations

The **ecos200** and **ecos202** intelligent unitary controllers are used for individual regulation of the temperature, air quality or humidity in individual rooms, depending on the room occupancy. The **ecos205** and **ecos206** volume flow controllers are additionally equipped with an integrated static differential pressure sensor, and are therefore suitable for individual volume flow control in individual rooms.

The **ecos208** and **ecos209** room automation stations feature a significantly more extensive I/O mix and also support electrical functions such as lighting, blind control or window monitoring.





All **SAUTER ecos** have these special features:



1. Flexibility: free programming of the user software, and largely free assignment of inputs and outputs, enable individual adaptation of functionality to customers' requirements.
2. Reliable and safe operation: the devices operate with complete autonomy. This means that functionality continues to be guaranteed even if there is a bus failure.

Thanks to the wiring box (available as an option) with its integrated cable fixture, the **ecos208/209** can be fitted without an additional housing. This substantially reduces the costs of the installation materials required.

4.2 ecoUnit room operating units

The room operating units are connected to the **SAUTER ecos** intelligent unitary controllers or room automation stations via a three-wire interface.

Type				
	EY-RU210F001	EY-RU211F001	EY-RU214F001	EY-RU241F001
Name	ecoUnit210	ecoUnit211	ecoUnit214	ecoUnit241
Use	Temperature sensor	Temperature, setpoint correction	Temperature, occupancy, setpoint correction, fan	Temperature, occupancy
Display	–	Scale ±	LED	LCD
Data transmission	Cable	Cable	Cable	Cable
Push-button functions	–	Rotary knob	Rotary knob + 2 push-buttons	2
Fan speeds	–	–	auto - 0 - 1 - 2 - 3	–
Setpoint correction	–	adjustable	adjustable	adjustable
Room occupancy	–	–	3 modes	–
Sensor	NTC	NTC	NTC	NTC
Power supply	from ecos 2	from ecos 2	from ecos 2	from ecos 2

Type			
	EY-RU244F001	EY-RU246F001	EY-SU306F001
Name	ecoUnit244	ecoUnit244	ecoUnit306
Use	Temperature, occupancy, setpoint correction, fan	Temperature, occupancy, setpoint correction, fan, lighting/window blinds	Temperature, occupancy, control of lighting and window blinds
Display	LCD	LCD	–
Data transmission	Cable	Cable	Cable
Push-button functions	4	6	6
Fan speeds	auto - 0 - 1 - 2 - 3	auto - 0 - 1 - 2 - 3	–
Setpoint correction	adjustable	adjustable	–
Room occupancy	3 modes	3 modes	–
Sensor	NTC	NTC	–
Power supply	from ecos 2	from ecos 2	from ecoUnit216/24.

Tab. 5 ecoUnit room operating units

Depending on their type, the room operating units have the following functions:

- Temperature measurement
- Adjustment of room setpoint
- Setting an operating mode
- Control of a 3-speed fan
- Control of one or two lighting groups with dimmer
- Control of blinds

SAUTER ecos room automation

The range for setpoint adjustment can be selected freely (basic setting: ± 2 K). A push-button is available to select three different operating modes. The functions for the operating modes can be freely programmed in the ecos intelligent unitary controller. The selected operating mode is shown on the room operating unit by three LEDs, or on an LCD display. Another push-button allows control of a 3-speed fan. The operating status of the fan is shown by four LEDs (Auto – I – II – III) or on an LCD- display. On the **ecoUnit214** and **ecoUnit216** room operating units, there are 2 additional push-buttons to control lighting or blinds. These two devices can also be extended with an external switching unit (**EY-SU306**) to add another six push-buttons.

The **ecoUnit 2** room operating units can be labelled freely with text and symbols. Both recessed and surface mounting are possible. The units are always mounted with the help of a frame which can come either from the SAUTER range or from the range of light switches from a third-party manufacturer. The standard inside dimension of the operating element, 55 x 55 mm, allows it to be installed in frames from many different manufacturers. Even unusual design requirements can therefore be met.

5 Local operation

The local operating unit **SAUTER modu240** (AS-based operation) and the **SAUTER modu250** touch-panel (operation throughout the AS network) are available to enable local operation of the plant in the MCC or directly from the technical installations. With suitable cabling, it is of course also possible to use PCs, tablet PCs and panel PCs etc., either as stations at management level or as web operating stations, for fixed or mobile local operation (see section: ‚Management level‘).

5.1 Local operating unit, modu240

The **modu240** local operating unit makes comprehensive information available locally regarding the process values and statuses of the relevant AS. With password protection, it is also possible to enter switching and positioning commands or to change parameters and time programmes.

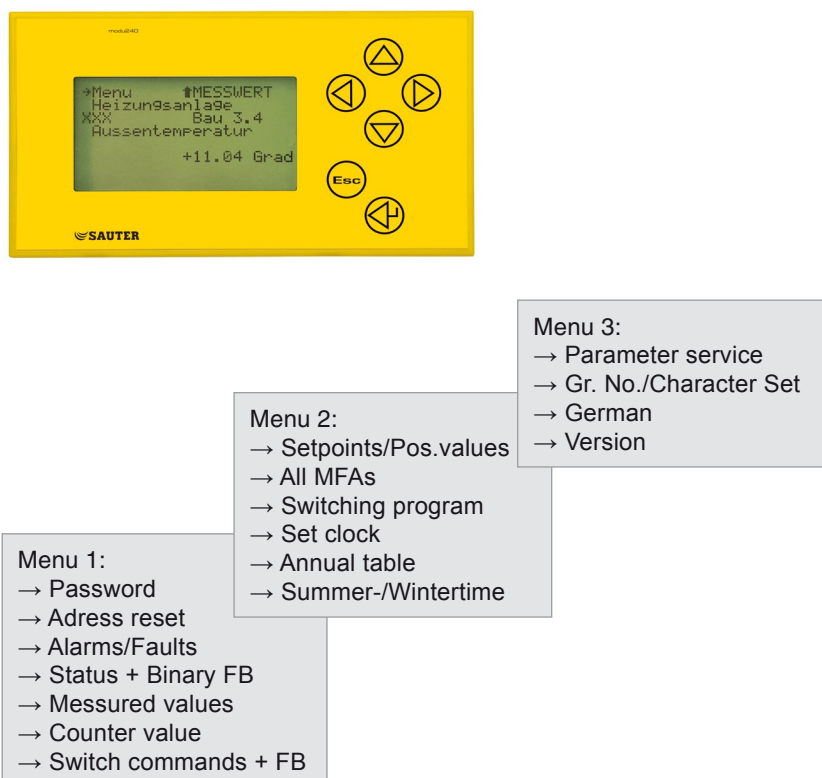

Fig. 2 Local operating unit, modu240

The **modu240** local operating unit is connected directly to the relevant automation station via an RJ-45 connector. The device can be installed in a fixed position or used as a mobile manual operating panel. It is mounted in the MCC either on an EN top-hat rail or with a fixing bracket in the front of the MCC.

Since all the engineering information and the data point attributes are stored in the **modu 2** automation stations, no programming at all is required for this operating unit. Once it is plugged into the AS, all parameters can be called up and operated immediately.

Local operation

Operation is menu-guided with six buttons. The illuminated LCD display, with eight rows of 21 characters each, allows comfortable operation even in poor lighting conditions.

Addresses are shown in plain text.

Example of an alarm	Bldg5+Heating N.-Pump Al	House address	24 characters
	Motor protection, heating pump north	Address text	32 characters
	TRIGGERED	Alarm status	16 characters

5.2 modu250 touch-panel

The **modu250** touch-panel with its pressure-sensitive graphic user interface is used for comprehensive visualisation and operation of automation stations integrated in **novaNet** throughout the network.

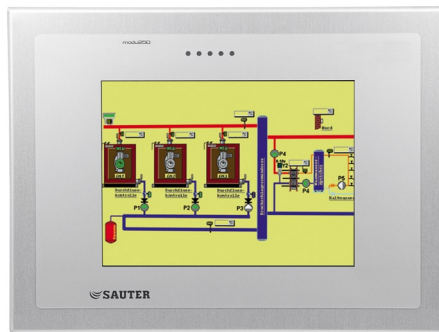

Fig. 3 modu250 touch-panel

With the **modu250** touch-panel, the addresses present in the automation stations, such as measured values, alarms, status signals etc., can be shown in both graphic and text form. Setpoints and positioning values can also be entered, commands can be executed and alarms can be acknowledged. The time programmes and calendars stored in the automation stations can also be operated. Historic data can be displayed in tabular or graphic form. Individual access rights can be assigned to the users for these purposes.

Menus are used to select data for the display and operation of the addresses and time programmes in text fields, and to display historic data in graphic and table form. No programming of the touch-panel is required in order to do this. Moreover, with the help of the **CASE TPC** configuration software, graphic plant schematics can be created to visualise and operate the plants.

Simple operation by touching the screen enables the touch-panel to offer a high standard of local operating comfort. The touch-panel is available in versions with a black-and-white or colour display.

- Display size (W×H): 140×105 mm
- Resolution: 320×240 (QVGA)

6 novaNet communication network

All stations at automation level communicate via the plant-wide **novaNet** system bus, which is optimised for building automation. This is the central element in the **SAUTER EY-modulo 2** system.

The communication bus, which is optimised for building automation, features a simple structure and high noise immunity. The free choice of bus topology and the extensive range, even without active components, also help to keep installation costs down.

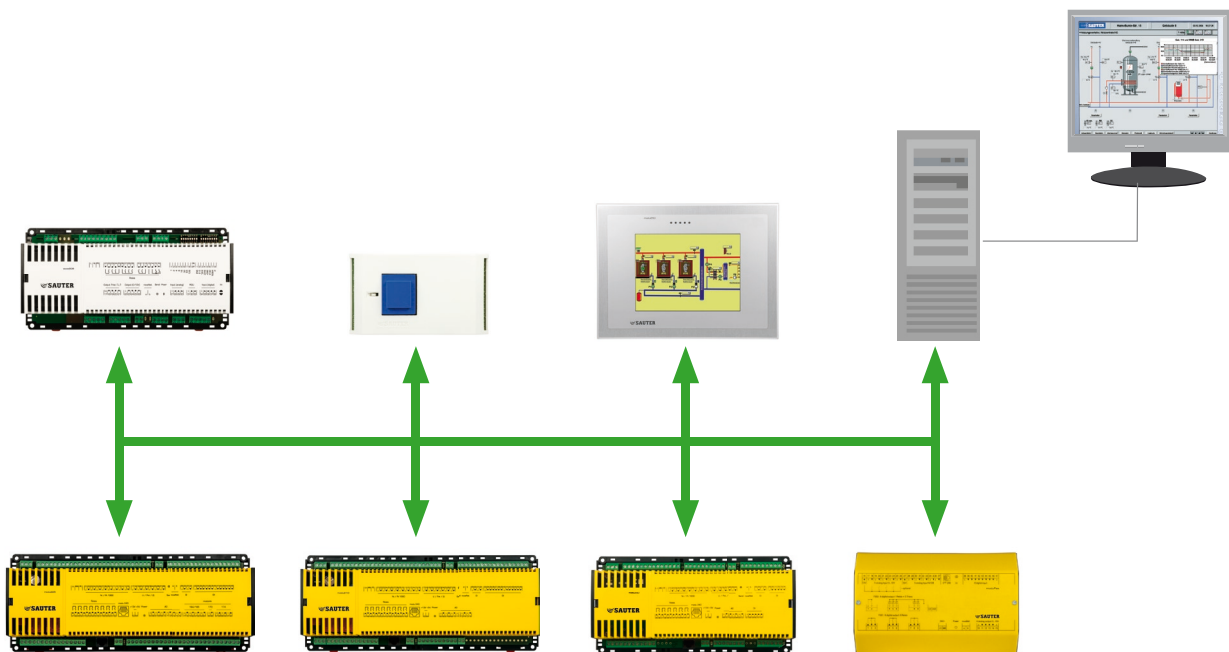

Fig. 4 novaNet

The participants, who have equal rights, exchange data via cross-traffic (real peer-to-peer communication), giving them functional autonomy and complete independence from the management level. Event-orientated data transmission reduces data traffic, ensuring short reaction times.

The structure of **SAUTER novaNet** corresponds to the internationally standardised layer model as per OSI. The bus has been optimised so as to attain the highest possible transmission speed with free topology (star or tree structure) and a wide range.

novaNet communication network

6.1 novaNet specifications

- Wire pair, twisted, screening recommended
 - max. loop resistance: 300 Ω
 - max. capacitance: 200 nF
- of which each station requires: 0.6 nF
- Signal run time: max. 30 μsec
- Transmission speed: 19200 Baud
- Data width: 32 bit
- Standard data transmission cable: CU cable, screened, twisted pairs (124 Ω/km, 48 nF/km)
- Range: 2.4 km for 141 Stationen

For cable lengths < 2.4 km, the number of stations can be increased as per the following chart (e.g. 1.6 km cable length, 200 stations)

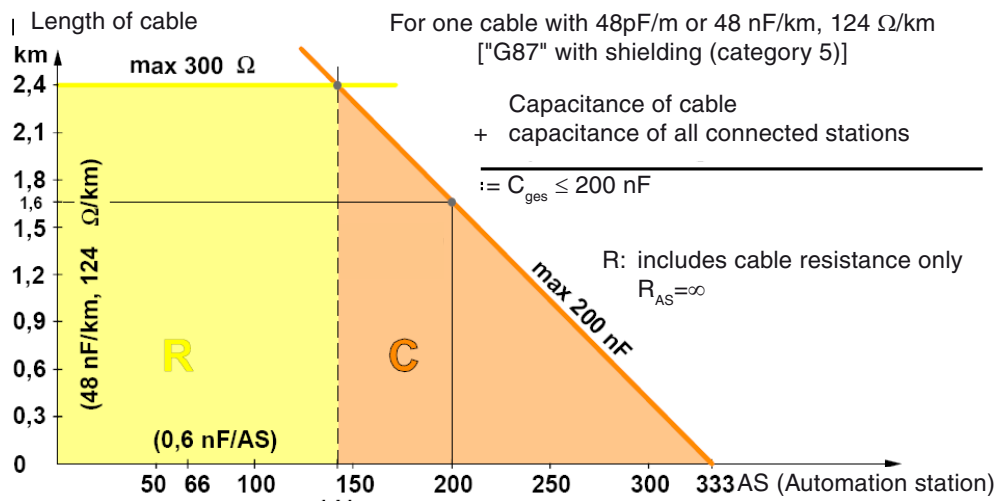

Fig. 5 novaNet performance chart

If a greater range or a larger number of participants is required, the **SAUTER novaNet** can be extended practically by using up to 200 **moduNet180** repeaters.

In theory, up to a maximum of **28,672 automation stations** (AS or IRC) and **256 PCs** can be addressed in one **novaNet**.

When intelligent unitary controllers are used, and occasionally in the case of automation stations, we encounter identical tasks for a whole group of devices. In order to simplify engineering and display at management level, 'identical devices' can be grouped together. A total of **3,071 logical groups** are available for this purpose.

6.2 moduNet180 repeater

The **SAUTER moduNet180** repeater is used to extend the **EY-modulo 2 novaNet** system bus via fixed wire or OWG connections.

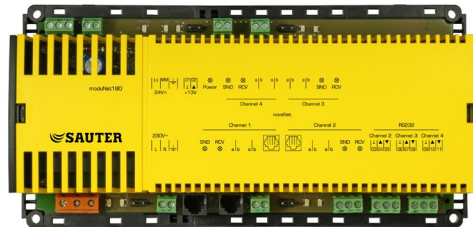

Fig. 6 moduNet180

This device can be used to cope with very large distances and to connect additional AS/PC participants in a network. The **moduNet180** repeater has four channels with equal rights, three of which are additionally designed as RS232s for transmission via OWG (via an RS232-OWG converter). Incoming telegrams are amplified and forwarded to the other three channels. The repeater is fully transparent within **novaNet**.

Up to 200 **moduNet180** repeaters can be used in one **novaNet**.

A maximum of 3-4 repeaters can be cascaded. Larger networks are usually implemented with a backbone structure.

6.3 moduNet292 Ethernet interface

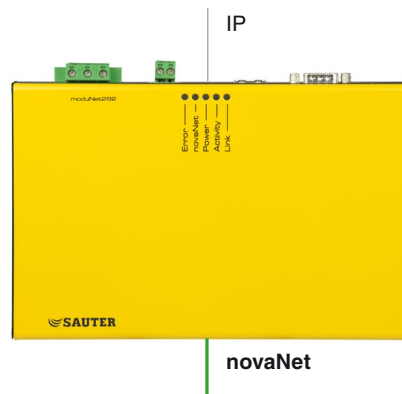

Fig. 7 moduNet292

The **moduNet292** novaNet Ethernet interface makes it possible to connect **novaNet** to Ethernet/IP in order to connect the PCs at management level with the **novaPro** visualisation software and/or the **CASE Suite** engineering software.

The **moduNet292** interface is configured from the PC, using the **novaNet292** configurator.

In theory, up to 256 **moduNet292** Ethernet interfaces can be connected for each **novaNet** network. Each **moduNet292** interface supports a management level client (novaPro and/or CASE).

novaNet communication network

6.4 novaNet291 router

The **novaNet** router, **novaNet291**, is used to connect novaNet networks via communication networks that are not connected permanently (,switched networks', usually the telephone network). The connection can be either created and removed again as necessary via the relevant menu in the management software (**remote access function**), or (if configured for this purpose) controlled by the router on an event-orientated basis (**remote monitoring function**).

The **novaNet291** router is designed so that it is compatible with all RS232 communication devices (modem, ISDN adapter etc.) that are controlled via character control chains (AT-commands or similar).

In terms of hardware, the **remote access function** (top-down selection) is identical with the **remote monitoring function** (bottom-up selection). Both the functions can therefore be combined and mixed as desired.

The **novaNet291** router does not enable any **novaNet-novaNet** connections. Switching is always handled via a computer's modem at management level.

6.4.1 Remote access function

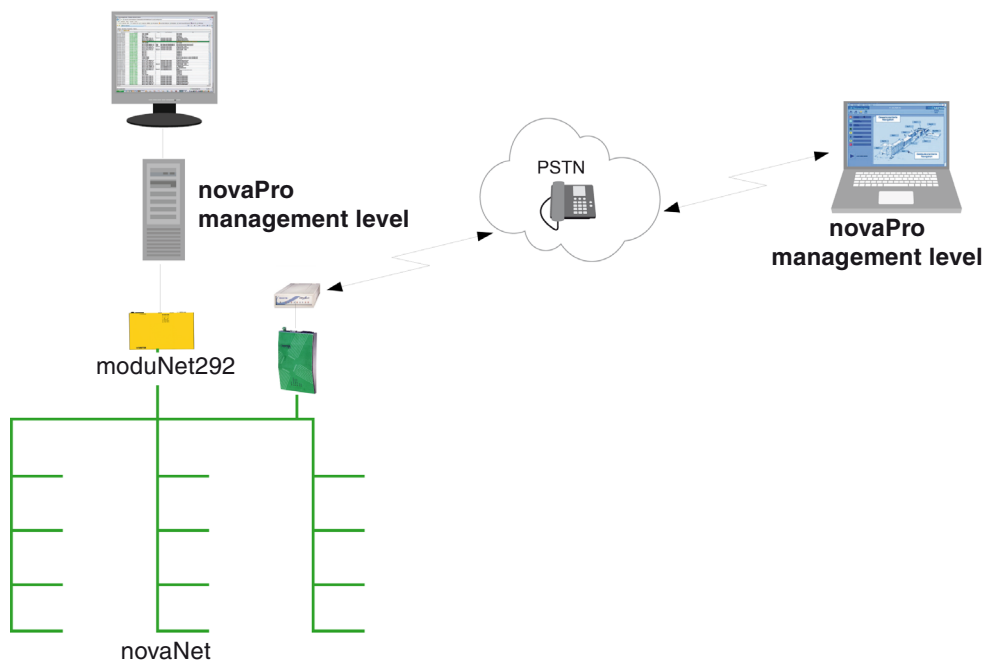

Fig. 8 Remote access function

The **remote access function** allows access to a plant from a remote PC with the **novaPro** management level (e.g. notebook with modem), or access from management level to a remote plant.

If necessary, the connection is created and removed again via the relevant menus in the management software.

6.4.2 Remote monitoring

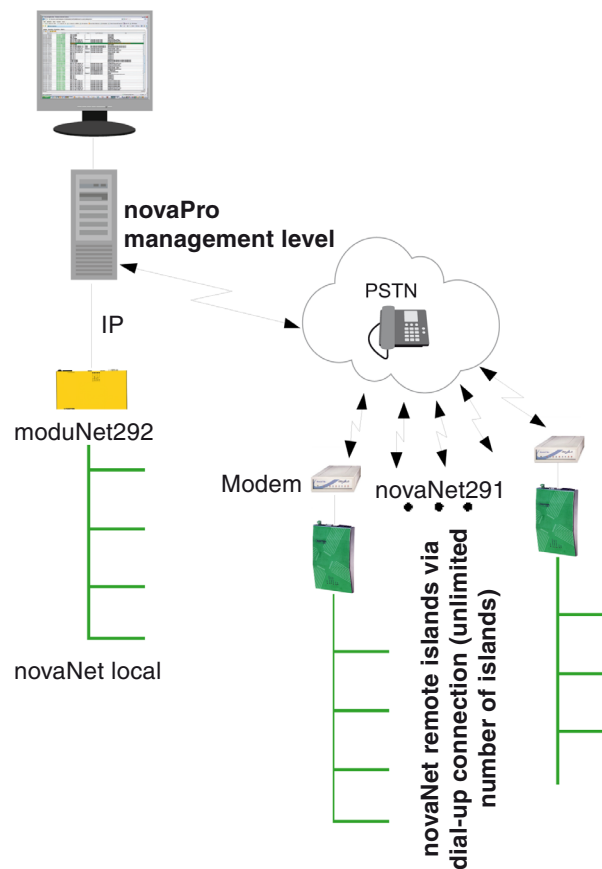

Fig. 9 Remote monitoring

The **remote monitoring** function allows the connection of remote AS islands (buildings) to a central management level, so that appropriately configured events (alarms, limit value violations etc.) can be signalled to it automatically.

The number of islands per management level is unlimited.

For each island, up to four routers are possible, with dialled connections to four different management level stations.

Each island has the full **novaNet** functionality and additional management stations can be connected locally.

The event-controlled establishment of the connection by the router can be freely configured as regards the character command chain, repeat sequences in case of 'busy' etc.

Events and addresses that trigger connections are configured in the AS.

novaNet communication network

7 Management level:

Normal commercial PCs with the MS Windows operating system are used for visualisation and operation etc. at management level. All available models such as desktop, notebook, tablet and panel PCs etc. can be used for this purpose. The web operating function also allows the plants to be operated via other devices such as PDAs, mobile phones with Pocket Windows (smart phones) etc.

7.1 novaPro software management level

novaPro is the family of SAUTER management level software systems that is tailored to the EY-modulo system.

It is used for comprehensive visualisation and operation etc. of the building's technical installations. All the information is collated and evaluated here. Alarms are triggered, signals undergo further processing, events are logged and data are evaluated.

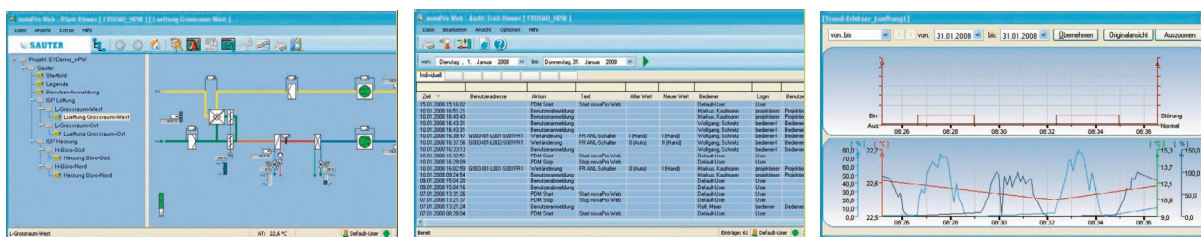

Fig. 10 novaPro management level

The management level also provides a rapid overview of energy and media consumption figures, so that targeted measures can be implemented to optimise consumption. The effectiveness of the measures taken can be verified immediately thanks to historical data recording.

All novaPro software systems have a variety of communication capabilities. Operating stations can be positioned throughout the network, and alarms and signals can be forwarded via various media to different output destinations such as e-mail addresses and mobile telephones etc. Access to the plant can also be gained from remote or mobile operating stations via switched or permanently connected networks.

A choice of three different software solutions is available for the management level under the novaPro product name. All three offer comprehensive functionality for the management level. The main differentiating features are:

SAUTER novaPro32 has a very comprehensive functionality that is tailored to the requirements of building management technology. Its special hallmarks are intuitive, simple operation and a very favourable price, not only for the product itself but also thanks to the very lean engineering requirements. **Sauter novaPro32** does not offer web functionality or any options for non-Sauter connections at management level.

Management level:

SAUTER novaPro Open is a very powerful SCADA application (SCADA = Supervisory Control and Data Acquisition) that features simply unlimited possibilities. In addition to comprehensive standard functionality, it supports the possibility of data processing (,soft SPS'), operation via a web browser and integration possibilities for a large number of non-Sauter systems.

SAUTER novaPro Web is the new SAUTER management level software that is perfectly tailored to building automation requirements. It has comprehensive functionality and up-to-date features such as web operation, which are implemented with cutting-edge technology. It is built up around a kernel containing the SQL database with BACnet objects, in line with the latest trends for open architecture. Furthermore, appropriate drivers can be used to integrate all further SAUTER EYs and a large number of non-Sauter systems. **novaPro Web** has been developed by SAUTER, so it is well matched to the **SAUTER CASE Suite** engineering tools. This means that the necessary engineering can largely be handled on an automated basis.

7.2 novaWeb embedded web server

The **novaWeb** embedded web server allows the operation of small or medium-sized plants via a web browser, even without the management level.

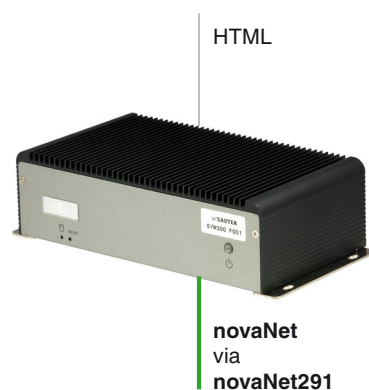

Fig. 11 novaWeb embedded web server

It permits access to the integrated plants with the help of a standard internet browser that is installed on a PC or another computer with an intranet/internet connection. The plant can therefore be monitored and controlled from any desired point (wireless LAN, UMTS etc.) with simple clients such as PDAs and smart phones.

novaWeb is connected to **novaNet** via the **novaNet291** router.

To protect against unauthorised access, the web server has four password levels for the different access options, as well as an integrated and configurable firewall.

SAUTER novaWeb requires engineering only as an option. It scans the **novaNet** automatically for the automation stations connected in it, and reads the content of these automation stations. On the basis of the read data, the web pages are generated automatically; examples include the alarm list, control loop overview page and plant-specific data point lists etc.

As well as these automatically-generated pages, it is also possible to add plant schematics and function descriptions, menus designed to customer-specific requirements with links to other devices (web servers, webcams) or documents (manuals etc.).

The integrated e-mail function allows cyclical dispatch of plant-related data, e.g. for remote optimisation of the connected plants.

8 Backwards and upwards compatibility, non-Sauter connections

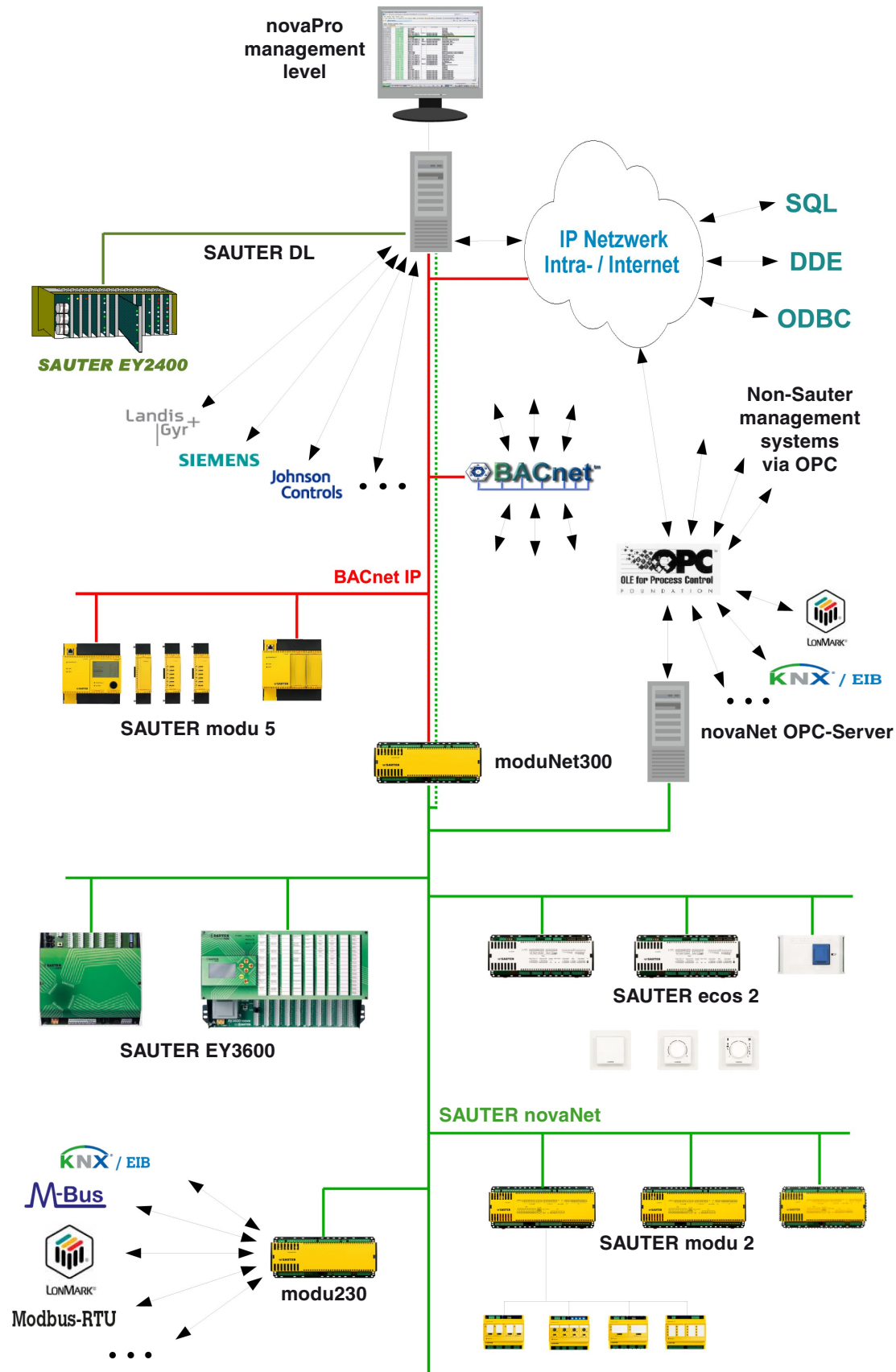

Fig. 12 Backwards and upwards compatibility, non-Sauter connections

Backwards and upwards compatibility, non-Sauter connections

The **SAUTER EY-modulo 2** system is compatible in all respects with the other SAUTER systems, and is totally open for non-Sauter connections!

8.1 Direct backwards compatibility with SAUTER EY3600

The **SAUTER EY-modulo 2** system uses the same **novaNet** data bus and the same core technology as the **SAUTER EY3600** system. This creates 100% compatibility between the two systems. This applies to the stations, the management level and the programming (engineering tools). The expansion of EY3600 systems with **EY-modulo 2** requires no outlay on migration.

8.2 BACnet and SAUTER EY-modulo 5 via moduNet300

Upwards or forwards compatibility with the **SAUTER EY-modulo 5** system is achieved via the **novaNet-BACnet Application Master moduNet300**. In this way, **EY-modulo 2** systems (or EY3600 systems) can be expanded with **EY-modulo 5** (or other BACnet systems), or vice-versa.

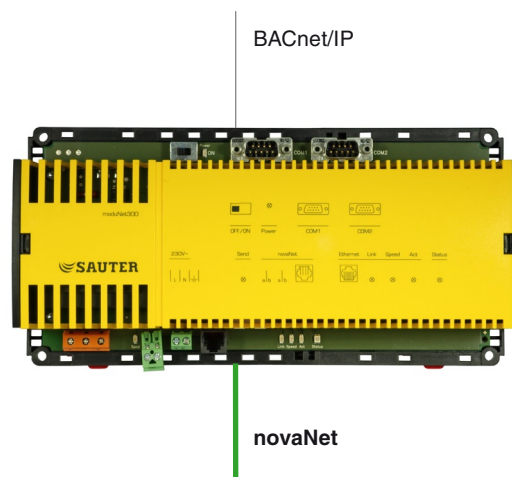

Fig. 13 moduNet300

The novaNet-BACnet Application Master **moduNet300** integrates the **SAUTER EY-modulo 2** automation stations and room controllers (as well as EY3600 stations) connected via the novaNet into the open, standardised BACnet/IP communication protocol.

As a BACnet server, it makes the novaNet-AS addresses available as BACnet objects with the associated properties and the required services. As a BACnet client, the **moduNet300** supports peer-to-peer transmission with 'Present Value Properties'.

Notification Class and Event Enrollment objects are supported for alerting and event notification.

Thanks to the scheduler (daily and weekly calendar) that is also implemented, and the ‚Schedule‘ and ‚Calendar‘ BACnet objects connected to it, local BACnet time programmes can be processed so that process variables for the connected **modu 2** automation stations can be controlled on a time-dependent basis.

Historical data can also be run on the **moduNet300** with dynamically created BACnet Trendlog objects. These data are stored persistently on the **moduNet300**.

The BACnet objects can be read by the BACnet clients either via a cyclical polling process or actively via the COV Subscription (Change Of Value Subscription) mechanism in the **moduNet300**.

For an engineered house address, the addresses used in the **EY-modulo 2** (or EY3600) automation stations are automatically converted by the **moduNet300** into BACnet objects and are updated. No additional outlay is incurred for generation.

The processing capacity for BACnet objects per Application Master **moduNet300** is a total of 1000 objects. Each **moduNet300** used in the **novaNet** needs a **novaNet** PC address.

The configuration of the IP address and other parameters is handled with a software tool in **SAUTER CASE Suite**, the ‚**BACnet Server Configurator**‘.

8.3 Non-Sauter systems at AS level via modu230

The integration of systems from other manufacturers is implemented at AS level via the **modu230** station:

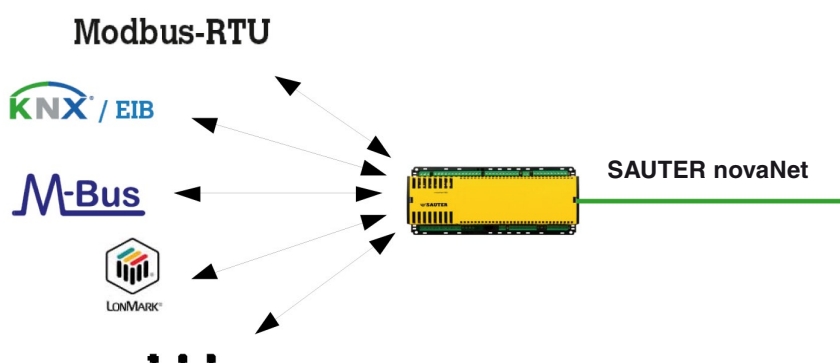

Fig. 14 Non-Sauter systems at AS level

The **modu230** is an automation station in the EY-modulo 2 system family with an additional interface function. On the one hand, it has the control and regulation functions of a normal **EY-modulo 2** AS, but it also has an interface for non-Sauter connections, via which the data from or for a non-Sauter system can be received or sent.

Backwards and upwards compatibility, non-Sauter connections

22 inputs and 10 outputs (using screwed terminals) are available so that field devices can be connected directly. The connection to the non-Sauter system is made via a freely programmable serial interface. 236 addresses/data points are available for this data exchange.

Likewise, the logical AS functions for regulation, control, optimisation, monitoring etc. are available for the directly-connected plant devices, and also for the integrated addresses of the non-Sauter system.

Depending on the particular non-Sauter system, data traffic is handled via an RS232 point-to-point connection or a bus coupler to a bus system.

The non-Sauter system connection of the modu230 can be programmed freely. The appropriate data protocols for various non-Sauter systems (building automation systems, fire detection systems, security systems, access control systems etc.) are available ex works, so these connections require only the configuration of the transmitted addresses/data points with the help of lists.

Currently-available protocols (document date):

- M-Bus
- LON (Sysmik)
- EIB (Elka)
- Modbus RTU (RS232/RS485 converter)
- Grundfos
- Wilo (interface converter)
- Siemens 3964R/RK512
- Danfoss VLT6000 / VLT2800

Please contact us for the latest status of connections available ex works, or to implement additional connections.

8.4 OPC-compatible management systems via novaNet OPC server

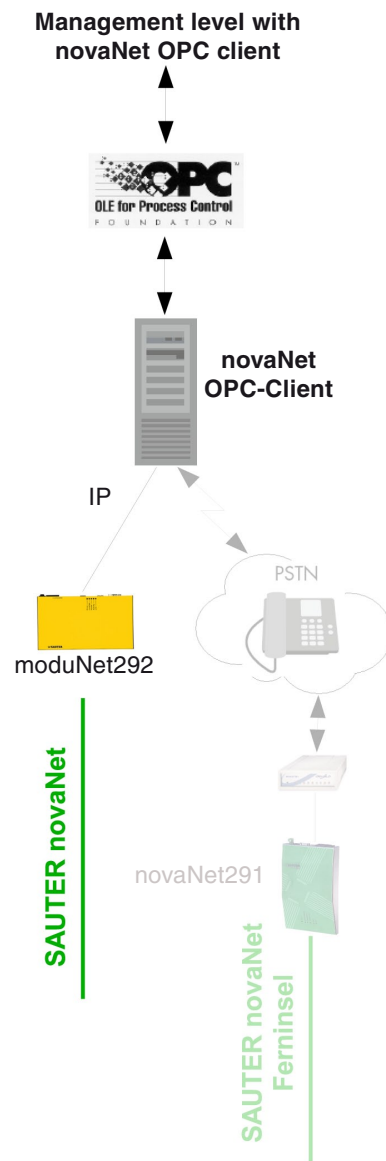

Fig. 15 novaNet OPC server

The **novaNet OPC server** can be used to integrate **EY-modulo 2** systems into non-Sauter management levels that have an OPC client interface. In this way, for example, it is also possible to meet specific customer requirements for a non-SAUTER management level such as Panorama, Wonderware, iFix, Citect, Factory Link etc. in a SAUTER system.

The **novaNet OPC server** is a PC program with a standardised OPC interface, designed according to the OPC Data Access 2.0 specification.

OPC data exchange with the automation stations on the connected **novaNet** is supported, e.g. for status changes, switching commands, measured values, setpoint specifications, historic database enquiries etc. In addition, the software has an ActiveX component that can be integrated into the non-Sauter

Backwards and upwards compatibility, non-Sauter connections

visualisation software as visualisation (and configuration) for the **EY-modulo 2** time programmes, if it supports these ActiveX components (i.e. if it is an ActiveX container).

The OPC server software can run on the same computer as the OPC client, or the OPC server and client can run on different computers and can communicate via a LAN (,DCOM variant').

The connection(s) between the OPC server PCs and the novaNet(s) are handled via the novaNet-Ethernet interface, **moduNet292**. With the **novaNet291** router, the connection can also be made via modem sections (for remote novaNet islands).

The **novaNet OPC server** is configured with the help of configuration files. Since the **novaNet OPC server** also supports the OPC browser interface, the OPC items in the server (with the relevant MFAs) can also be generated online by the OPC client.

(The **SAUTER novaPro** software solutions also have OPC server (and/or OPC client) functions in some cases. See the next section)

8.5 Non-Sauter and SAUTER systems via novaPro

The SAUTER management level software solutions, **novaPro Open** and **novaPro Web**, have a very varied range of connection possibilities. They support the connection of all **SAUTER EY systems** and a large number of non-Sauter systems and various databases.

In addition, solutions for all further connections that are not available as standard can be found on the basis of the available technologies and tools.

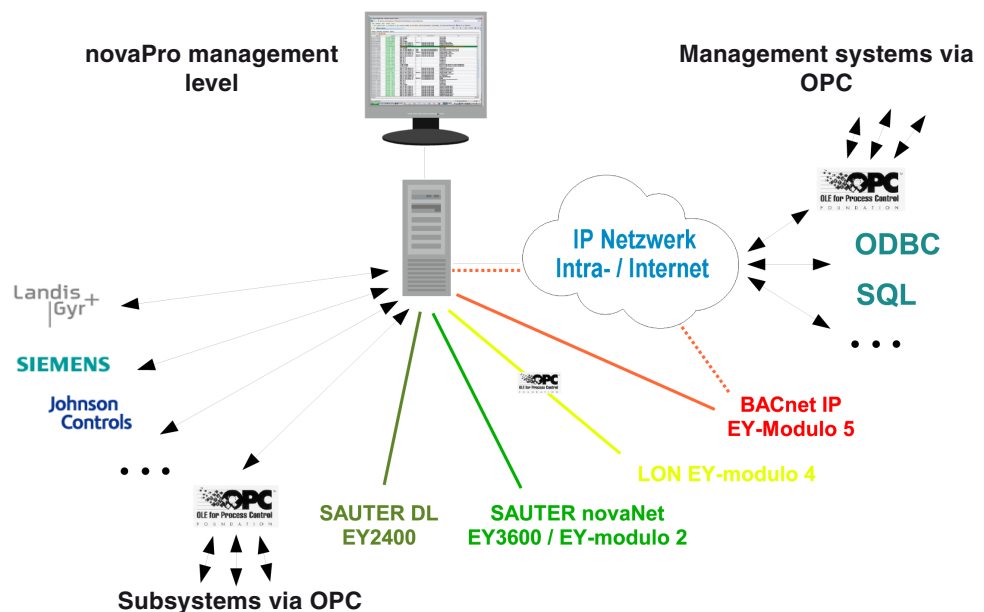

Fig. 16 Non-Sauter and SAUTER systems via novaPro

8.5.1 SAUTER EY3600

SAUTER EY3600 is 100% bus-compatible with **SAUTER EY-modulo 2**.

Accordingly, the management level can process all the process data of the two systems with all variants of novaPro.

8.5.2 SAUTER EY2400

SAUTER EY2400 systems with or without LZ4, LZ10 can be integrated with the relevant drivers via **novaPro Open** or **novaPro Web** into **EY-modulo 2**, or existing EY2400 systems can be expanded in this way with **EY-modulo 2** stations.

The control centre, including its functions, is replaced by the SCADA functions of **novaPro Open** or **novaPro Web** in this case. The control centre can be programmed by a tool (conv_EY2400) for this purpose.

Cross-communication between the **EY2400** and **EY-modulo 2** stations is implemented via the SCADA functions of the **novaPro** software.

8.5.3 LON, SAUTER EY-modulo 4

SAUTER EY-modulo 4 stations that use the standardised LONWorks protocol, or non-Sauter LON stations, are integrated into the SAUTER management level with **novaPro Open** or **novaPro Web** via the LON-OPC server in their OPC client.

The relevant LON-OPC server can be obtained from SAUTER or from a third supplier.

8.5.4 BACnet, SAUTER EY-modulo 5

As well as integration via **moduNet300** (see above), **SAUTER EY-modulo 5** and other BACnet systems can also be integrated by means of the appropriate drivers via **novaPro Open** or **novaPro Web** into **EY-modulo 2** systems, or existing **EY-modulo 2** systems can be expanded in this way with **EY-modulo 5** or other BACnet stations.

Cross-communication between the BACnet stations and the **EY-modulo 2** system is implemented via the SCADA functions of the **novaPro** software in this case.

Whether the connection between BACnet and **novaNet** should be implemented by means of the **novaPro** management level, or by the novaNet-BACnet Application Master **moduNet300**, or both transitions, is a question that must be decided separately in each specific case on the basis of the number of addresses and data flows etc. involved.

Backwards and upwards compatibility, non-Sauter connections

8.5.5 Non-Sauter systems via drivers

A large number of data bus drivers for the various building technology systems are available for the SAUTER management level software solutions, **novaPro Open** and **novaPro Web**, such as:

- Johnson Controls System 91, N2 Protocol
- Landis & Gyr PRV 1 Controller
- Landis & Gyr PRV 2 Controller
- Siemens SIMATIC S5 / S7, TCP/IP (vpiwnstp)
- OPC client as per OPC Data Access 2.0 specification
- OPC LonWorks through LNS database
- OPC LonWorks native LNS / LCA
- Modbus RTU / Modbus IP
- Amadeus PMS (hotel reservation system via IP)

On the basis of the available technologies and tools, it is also possible to find suitable solutions for other connections that are not available at present.

8.5.6 Non-Sauter systems via databases

The SAUTER **novaPro Open** and **novaPro Web** management level software systems support data exchange with databases via DDE, ODBC, SQL and OPC:

- Standard DDE (Dynamic Data Exchange) functions and block DDE functions are available in **novaPro Open** both as clients and servers.
- The SQL module is a highly flexible means of connecting with the most common standard databases via the Microsoft ODBC interface. This makes it easier to configure data exchange with other applications and databases such as the Microsoft SQL server, Sybase and Oracle etc.
- Event-controlled SQL or ODBC enquiries can be used to read data from existing databases (**novaPro Open** only), and to write real-time data or historic data to databases (e.g. to transmit current meter readings to ERP systems).
- The standardised OPC data exchange (OLE for Process Control) can be used to integrate various non-Sauter systems that also have their own OPC server/client (see also above).

9 Additional documentation

For additional documentation and training on the products and the use of the EY-modulo 2 system, please refer to our web site, www.sauter-controls.com or contact any SAUTER branch.

Figures

Fig. 1	System overview	7
Fig. 2	Local operating unit, modu240	19
Fig. 3	modu250 touch-panel	20
Fig. 4	novaNet	21
Fig. 5	novaNet performance chart	22
Fig. 6	moduNet180	23
Fig. 7	moduNet292	23
Fig. 8	Remote access function	24
Fig. 9	Remote monitoring	25
Fig. 10	novaPro management level	27
Fig. 11	novaWeb embedded web server	28
Fig. 12	Backwards and upwards compatibility, non-Sauter connections	31
Fig. 13	moduNet300	32
Fig. 14	Non-Sauter systems at AS level	33
Fig. 15	novaNet OPC server	35
Fig. 16	Non-Sauter and SAUTER systems via novaPro	36

Tables

Tab. 1	EY-modulo 2 automation stations	11
Tab. 2	moduLink field modules	13
Tab. 3	ecos 2 intelligent unitary controller	15
Tab. 4	ecos 2 room automation stations	16
Tab. 5	ecoUnit room operating units	17

© Fr. Sauter AG
Im Surinam 55
CH-4016 Basel
Tel. +41 61 - 695 55 55
Fax +41 61 - 695 55 10
www.sauter-controls.com
info@sauter-controls.com

Printed in Switzerland